

National Work Shop
On
Application of Fractional Calculus
in Engineering

March 9-11; 2012

RAIT Navi-Mumbai

Physical Law and Solving
Extra Ordinary Differential Equations of
Fractional Order

Shantanu Das Scientist H+, Reactor Control Division
BARC Mumbai 400085

shantanu@barc.gov.in

Formal methods to solve FDE

1. Laplace Transforms *
2. Indicial Polynomial & Generalized Partial Fractions *
3. Fractional Greens function *
4. Mellin Transforms
5. Power Series Method *
6. Babenko's Symbolic calculus method
7. Orthogonal Polynomial decomposition
8. Adomian Decomposition *
9. Order reduction (complementary polynomial)
10. Numerical *
11. Gelarkin Approximations and others like Homotopy methods

Picturing of Network Delay Dynamics

Shot noise driving a delay generation block (fractional Langevin's equation)

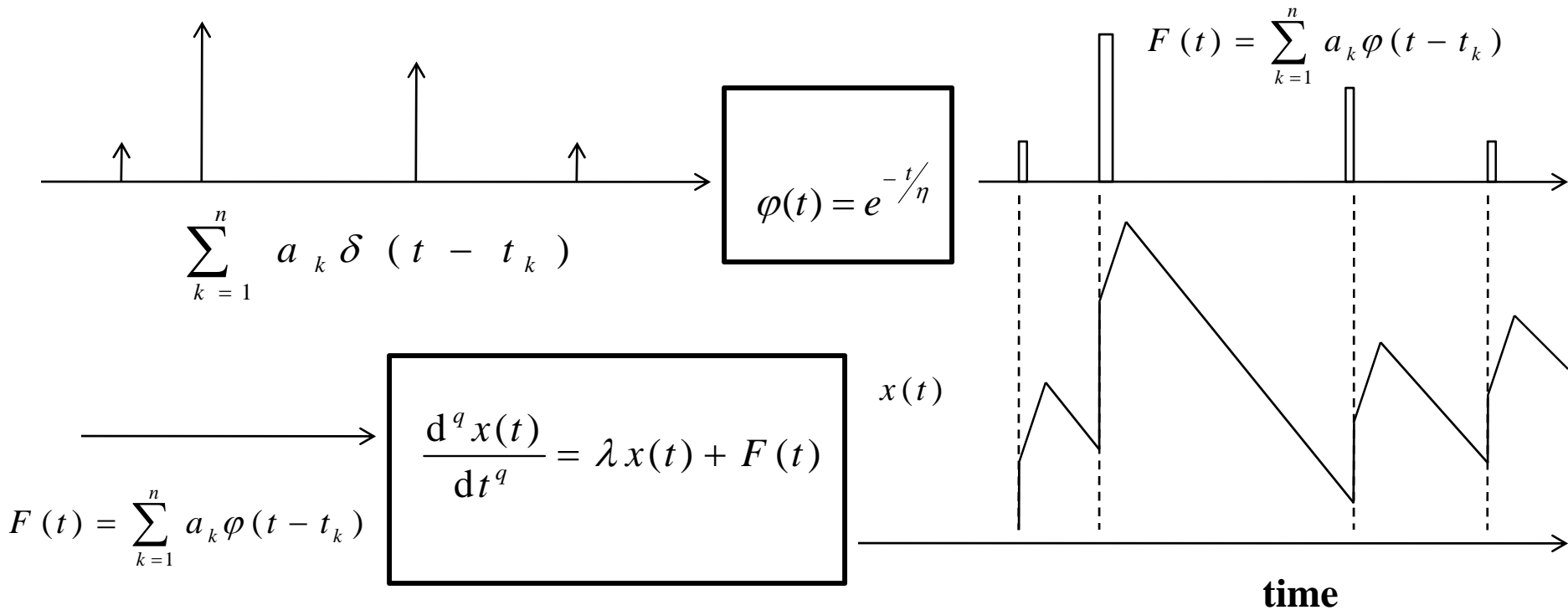

Solution of Fractional Langevin Equation

$$\frac{d^q x(t)}{dt^q} = \lambda x(t) + F(t)$$

Homogeneous equation $\frac{d^q x(t)}{dt^q} - \lambda x(t) = 0$. Laplace transforming this

$$s^q x(s) - x^{q-1}(0) - \lambda x(s) = 0$$

A fractional initial state is required!!

For time being say $x^{q-1}(0) = \left. \frac{d^{q-1}}{dt^{q-1}} x(t) \right|_{t=0} = x_0$

Using this we get Laplace solution as

$$x(s) = \frac{x_0}{(s^q - \lambda)}$$

Green's function (Laplace of inverse of indicial polynomial) $P(s) = s^q - \lambda$

Laplace inverse gives $x(t) = \mathcal{L}^{-1} \{x(s)\} = x_0 t^{q-1} E_{q,q}(\lambda t^q)$

This is solution with out external force

Solution of Fractional Langevin Equation

Force driven

Fractional

$$\frac{d^q x(t)}{dt^q} - \lambda x(t) = F(t)$$

$$x(t) = x_0 t^{q-1} E_{q,q}(\lambda t^q) + \int_0^t dt' F(t') (t-t')^{q-1} E_{q,q}(\lambda (t-t')^q)$$

$$E_{\alpha,\beta}(t) = \sum_{k=0}^{\infty} \frac{t^k}{\Gamma(\alpha k + \beta)}$$

**Two parameter Mittag-Leffler
Function (Higher transcendental)**

Integer Order

BM

$$\frac{dx(t)}{dt} - \lambda x(t) = F(t)$$

$$x(t) = x_0 \exp(\lambda t) + \int_0^t dt' F(t') \exp(\lambda (t-t'))$$

Power series functions used in fractional calculus

Higher Transcendental Functions

Exponential function forms basis in the integer order calculus so is **MITTAG LEFFLER** function for the fractional calculus

Mittag-Leffler

$$E_q(a t^q) = \sum_{n=0}^{\infty} \frac{a^n t^{nq}}{\Gamma(nq + 1)} \leftrightarrow \frac{s^q}{s(s^q - a)} = \frac{s^{q-1}}{s^q - a}$$

Agarwal

$$E_{a,b}(t^q) = \sum_{n=0}^{\infty} \frac{t^{\left(n + \frac{b-1}{a}\right)}}{\Gamma(na + b)} \leftrightarrow \frac{s^a}{s^b(s^a - 1)} = \frac{s^{a-b}}{s^a - 1}$$

Erdelyi

$$E_{a,b}(t) = \sum_{m=0}^{\infty} \frac{t^m}{\Gamma(am + b)} \leftrightarrow \sum_{m=0}^{\infty} \frac{\Gamma(m+1)}{\Gamma(am + b) s^{m+1}}$$

Robotnov-Hartley

$$F_q(a, t) = \sum_{n=0}^{\infty} \frac{a^n t^{(n+1)q-1}}{\Gamma(\{n+1\}q)} \leftrightarrow \frac{1}{(s^q - a)}$$

Miller-Ross

$$E_t(q, a) = t^q \exp(at) \gamma^*(q, at) = \sum_{k=0}^{\infty} \frac{a^k t^{k+q}}{\Gamma(q+k+1)} \leftrightarrow \frac{s^{-q}}{s-a}$$

Solution of FDE by Laplace-formal

$${}_0 D_t^{1/2} f(t) + b f(t) = 0$$

$$t > 0; \quad [{}_0 D_t^{-1/2} f(t)]_{@ t=0} = C \quad \text{Requiring fractional initial state?}$$

$$\mathcal{L} \left[f^{(n)}(t) \right] = s^n F(s) - s^{n-1} f(0) - s^{n-2} f^{(1)}(0) - \dots$$

$$\mathcal{L} \left[f^{(1/2)}(t) \right] = s^{1/2} F(s) - s^{1/2-1} f(0) = s^{1/2} F(s) - s^{-1/2} f(0)$$

$$\mathcal{L} \left[f^{(1/2)}(t) \right] = s^{1/2} F(s) - [{}_0 D_t^{-1/2} f(t)]_{@ t=0}$$

$$F(s) = \frac{C}{s^{1/2} + b}$$

$$f(t) = C t^{-1/2} E_{0.5,0.5}(-b \sqrt{t})$$

Solution of FDE with initialization function

$${}_0 D_t^{1/2} f(t) + b f(t) = 0$$

$${}_0 d_t^{1/2} f(t) + \psi(t) + b f(t) = 0 \quad \text{for } t > 0$$

$$s^{1/2} F(s) + \psi(s) + b F(s) = 0$$

$$F(s) = - \frac{\psi(s)}{s^{1/2} + b}$$

For specific

$$\psi(t) = -C \delta(t)$$

We get

$$F(s) = \frac{C}{s^{1/2} + b} \quad f(t) = C t^{-1/2} E_{0.5,0.5}(-b\sqrt{t})$$

Generally:

$$\mathcal{L}^{-1} \left[\frac{1}{s^{1/2} + b} \right] = R_{1/2,0}(-b, 0, t)$$

General Solution

$$f(t) = - \int_0^t R_{1/2,0}(-b, 0, t - \tau) \psi(\tau) d\tau$$

Robotnov-Hartley convoluted with initialized function

Fractional Initial State-physically ?

$$v(t) / K = D^\alpha \{i(t)\}$$

Impulse input

$$v(t) = B \delta(t)$$

$$i(t) = \frac{1}{K} D^{-\alpha} v(t) = \frac{1}{K} [\Phi_\alpha(t) * B \delta(t)] = \frac{B}{K} \Phi_\alpha(t)$$

$$\Phi_\alpha(t) = t^{\alpha-1} / \Gamma(\alpha)$$

$$i(t) = B t^{\alpha-1} / K \Gamma(\alpha)$$

$$v(t) = B \delta(t)$$

$$t > 0 ; v(t) = 0$$

Using $D^\alpha i(t) = v(t) / K = B \delta(t) / K$

$$[{}_0 D_t^{\alpha-1} i(t)]_{@ t=0} = [{}_0 D_t^{-1} \left[\frac{B \delta(t)}{K} \right]]_{@ t=0}$$

$$\int \delta(t) dt = 1$$

$$D_t^{\alpha-1} i(0) = B / K = C$$

Here also we have found that fractional initial state value a constant.

**Physical reality
in getting series solution of
general differential equation system**

Physical Law of

Action-Reaction

Advantages:

A modern approach to Solve Extra Ordinary Differential Equations

Series reaction of several internal-modes generated to external perturbation.

No Laplace Transformation.

No discretization required.

No perturbation required.

Gives the solution as analytical (approximate)

Close to physical reasoning of principal of action reaction.

Second Order System (un damped)

Oscillator to start with for demonstration

Consider a classical oscillator of integer-second order, mass spring system represented as:

$$m \frac{d^2}{dt^2} x(t) + k x(t) = f(t)$$

With initial conditions and forcing function defined as

$$x(0) = 0$$

$$\dot{x}(0) = 0$$

We can re-write the equation as:

$$f(t) = \delta(t)$$

$$\frac{d^2}{dt^2} x(t) = \ddot{x}(t) = D_t^2 x(t) = \frac{1}{m} f(t) - \frac{k}{m} x(t)$$

continue

$$\dot{x}(t) = \frac{1}{m} f(t) - \frac{k}{m} x(t)$$

This above equation gives insight into physical aspect of the process.

The RHS states the opposing action to a forcing function, which is manifested as motion is given by LHS of above expression.

At the initial time the displacement being zero with the velocity, implies that the displacement at just time $t = 0^+$ is due the forcing function; alone.

This displacement action is without any opposition.

This first displacement call it-zeroth mode as $x_0 = D_t^{-2} \frac{1}{m} f(t)$ due to external force and if initial conditions are present.

Due to nature of this forcing function as an impulse, the displacement (zeroth mode) takes the form as

$$x_0 = \frac{1}{m} D_t^{-2} \delta(t) = \frac{1}{m} t$$

This displacement action would be true, in the absence of any retarding or opposing element say spring or friction. (In case of above it is spring action). In absence of any opposition, the constitutive equation will be, $m\ddot{x}(t) = f(t)$ and for impulse force, the displacement will be linear function of time $x(t) = t/m$, with constant velocity $\dot{x}(t) = 1/m$

continue

The presence of spring makes the equation of motion as:

$$\ddot{x}(t) = \frac{1}{m} f(t) - \frac{k}{m} x(t)$$

the external excitation being opposed by the spring action by opposite spring force and is internally generated

$$f_i = -\frac{k}{m} x_{i-1}$$

$$i \geq 1$$

continue

The primary and the zeroth mode of displacement is due to external force on the mass that is

$$x_0 = \frac{1}{m} D_t^{-2} f(t) = \frac{1}{m} D_t^{-2} \delta(t) = \frac{1}{m} t$$

This zeroth mode of displacement is solely due to external excitation; since the initial conditions are at rest.

This displacement is now opposed by spring.

Due to this opposing element, the displacement caused by external force, the spring generates an opposing force (first mode, from zeroth mode displacement), as:

$$f_1 = - \frac{k}{m} x_0$$

and to this, new (internal force) the displacement would be

$$x_1 = D_t^{-2} f_1 = - \frac{k}{m} D_t^{-2} x_0 = - \frac{k}{m} D_t^{-2} \left(\frac{1}{m} t \right) = - \frac{k}{m^2} \frac{t^3}{3!}$$

continue

this displacement, again generates an internal force; inside the spring as

$$f_2 = -\frac{k}{m} x_1 = +\frac{k^2}{m^3} \frac{t^3}{3!}$$

and (again) to this force the displacement is second order mode.

$$x_2 = D_t^{-2} f_2 = -\frac{k}{m} D_t^{-2} x_1 = -\frac{k}{m} D_t^{-2} \left(-\frac{k}{m} \frac{1}{m} \frac{t^3}{3!} \right) = \frac{k^2}{m^3} \frac{t^5}{5!}$$

and so on.

In the absence of the spring, the opposing (internal) forces will be zero.

We can call this total displacement as sum of all the modal displacements from zero to infinity.

With zero modes being the only reaction to the bare excitation (and if any initial displacement and velocity be present), and all other modes are opposing reactions taking place in the spring, due to internal forces generated inside there.

The modes can be tabulated as in Table-1

continue

Table-1: Decomposing the action reaction of second order mass spring system

MODE	FORCE	DISPLACEMENT
0	$f_0 = \frac{1}{m} f(t) = \frac{1}{m} \delta(t)$	$x_0 = D_t^{-2} f_0 = \frac{1}{m} t$
Higher Modes	Higher Modal Internal Forces	Higher Modal Internal displacements
1	$f_1 = -\frac{k}{m} x_0 = -\frac{k}{m^2} t$	$x_1 = D_t^{-2} f_1 = -\frac{k}{m^2} \frac{t^3}{3!}$
2	$f_2 = -\frac{k}{m} x_1 = +\frac{k^2}{m^3} \frac{t^3}{3!}$	$x_2 = D_t^{-2} f_2 = +\frac{k^2}{m^3} \frac{t^5}{5!}$
3	$f_3 = -\frac{k}{m} x_2 = -\frac{k^3}{m^3} \frac{t^5}{5!}$	$x_3 = D_t^{-2} f_3 = -\frac{k^3}{m^4} \frac{t^7}{7!}$
.....

continue

Adding up all the (modal displacements- reactions), the solution to is obtained as (infinite) series:

$$x(t) = x_0 + x_1 + x_2 + x_3 + \dots = \frac{1}{m}t - \frac{k}{m^2} \frac{t^3}{3!} + \frac{k^2}{m^3} \frac{t^5}{5!} - \frac{k^3}{m^4} \frac{t^7}{7!} = \frac{1}{m} \left[t - \frac{k}{m} \frac{t^3}{3!} + \frac{k^2}{m^2} \frac{t^5}{5!} - \dots \right]$$

Multiplying the above series by $\sqrt{k/m}$
and dividing by same we get:

$$x(t) = \frac{1}{\sqrt{km}} \left[\sqrt{\frac{k}{m}} t - \left(\frac{k}{m}\right)^{3/2} \frac{t^3}{3!} + \left(\frac{k}{m}\right)^{5/2} \frac{t^5}{5!} - \dots \right] = \frac{1}{\sqrt{km}} \sin \left(\sqrt{\frac{k}{m}} t \right)$$

This is oscillator with natural frequency $\omega = \sqrt{k/m}$ radians per seconds.

This gives exact solution

First order system and its example of modal reactions

$$\dot{x}(t) + x(t) = f(t)$$

$$D_t^{-1} D_t^1 x(t) + D_t^{-1} x(t) = D_t^{-1} f(t)$$

$$x(t) - x(0) = D_t^{-1} f(t) - D_t^{-1} D_t^{-1} f(t) + D_t^{-1} D_t^{-1} D_t^{-1} f(t) - \dots$$

$$x(0) = 0, f(t) = \delta(t)$$

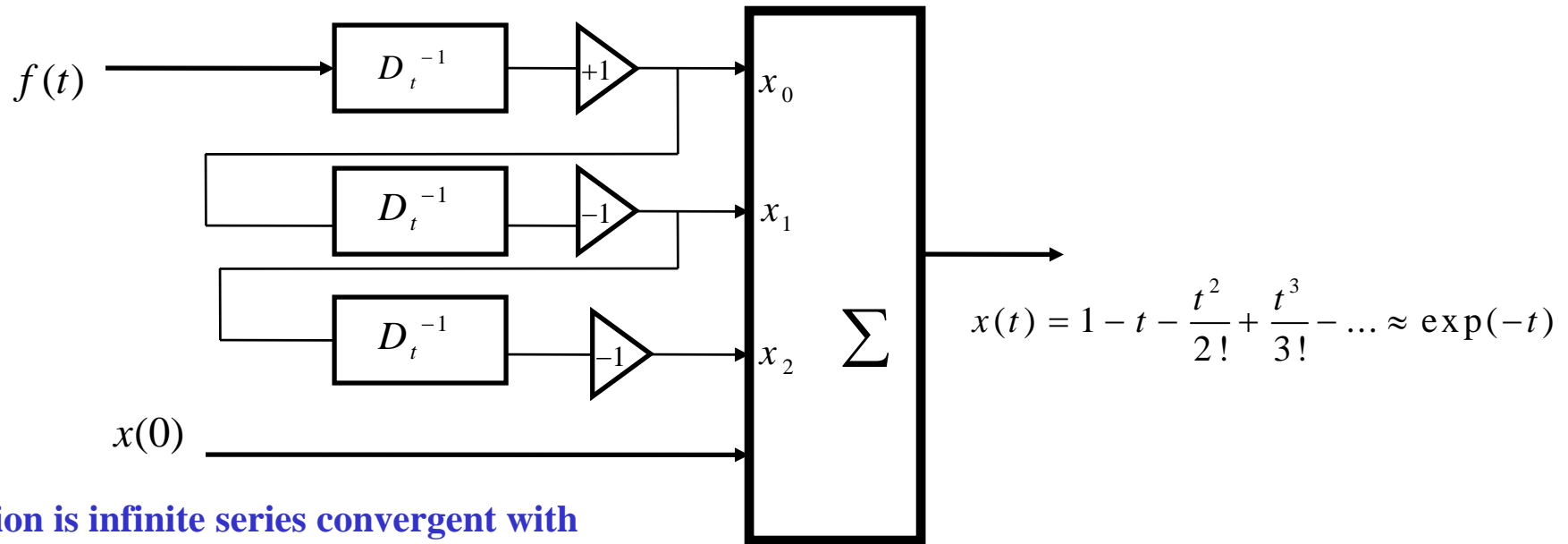

Solution is infinite series convergent with integer power terms.

Charging current of capacitor in RC circuit:

$$\frac{1}{C} \int_{0^+}^t i(t) dt + R i(t) = V_{BB} h(t) \quad \text{differentiating} \quad \frac{d}{dt} i(t) + \frac{1}{RC} i(t) = \frac{V_{BB}}{R} \delta(t)$$

$i(0) = 0$

At initial time zero, at the switch closer instance, gives impulse excitation-of current, and assuming if the capacitance of the circuit were absent-at this initial instant (capacitance comes into action at retarded time), then the current in the resistance is

$$i(t) = \frac{V_{BB}}{R} \int_0^t \delta(t) dt = \frac{V_{BB}}{R} D_t^{-1} \delta(t) = V_{BB} / R \quad \text{a constant.}$$

Here a point is mentioned that integration of the forcing function comes because the inertial element capacitance is present in the circuit and equation above. If the capacitor is completely absent then the current reaction will be simple

$(V_{BB} / R) \delta(t)$ meaning that the current would have vanished instantaneously with the impulse and the current would be then zero i.e. $i(t) = 0$ at $t \geq 0$ This initial moment current in resistor is V_{BB} / R

since initially uncharged capacitor acts as short circuit impedance. The capacitor presence is making the current linger for time greater than zero. The circuit as natural reaction to any force will oppose this flow of current that is the change in current from zero to V_{BB} / R is the capacitor action

Therefore, the first (and the foremost) reaction comes from the resistive element (without lag or lead). That is

$$i_0 = i(0) + D_t^{-1} [V_{BB} \delta(t) / R] = V_{BB} / R$$

in the absence of the capacitive element (initially short-circuited); and this is the first reaction due to external force (and initial current if at all be present in the circuit). This sudden, change in charges (Coulombs) cannot flow into capacitor, as the voltage across it cannot change instantaneously. This constant action of current gives rise to a rate of change of current in the system (per unit time constant) and is i_0 / RC A/s.

The, first reactionary constant current thus is opposed by internal generated current as $i_1 = -D_t^{-1} [i_0 / RC]$

which is in opposition to this first reactionary current initial reaction, therefore negative. This action reaction summed up to give $i(t) = i_0 + i_1$

continue

The internally generated reactionary current gives a rate of change as (i_1 / RC) A/s.

which will generate opposition current to the cause i_1 as $i_2 = -D_t^{-1}[i_1 / RC]$

which again is added to give total reaction as $i(t) = i_0 + i_1 + i_2$ as the total current.

$$i_0 = i(0) + D_t^{-1}[V_{BB} \delta(t) / R]$$

$$i_n = -\frac{1}{RC} D_t^{-1}[i_{n-1}]; n \geq 1$$

$$i_0 = V_{BB} / R$$

$$i_1 = -\frac{1}{RC} D_t^{-1}[V_{BB} / R] = -\frac{V_{BB}}{R} \frac{t}{RC}$$

$$i_2 = -\frac{1}{RC} D_t^{-1}\left[-\frac{V_{BB}}{R} \frac{t}{RC}\right] = \frac{V_{BB}}{R} \frac{1}{2!} \left(\frac{t}{RC}\right)^2$$

$$i_3 = -\frac{1}{RC} D_t^{-1}\left[\frac{V_{BB}}{R} \frac{1}{2!} \left(\frac{t}{RC}\right)^2\right] = -\frac{V_{BB}}{R} \frac{1}{3!} \left(\frac{t}{RC}\right)^3$$

$$i(t) = \frac{V_{BB}}{R} \left(1 - \frac{t}{RC} + \frac{1}{2!} \left(\frac{t}{RC}\right)^2 - \frac{1}{3!} \left(\frac{t}{RC}\right)^3 + \dots\right) = \frac{V_{BB}}{R} e^{-\left(\frac{t}{RC}\right)}$$

Decomposing the series solution for the first order system:

$$u(t) = \frac{V_{BB}}{R} \left(1 - \frac{t}{RC} + \frac{1}{2!} \left(\frac{t}{RC} \right)^2 - \frac{1}{3!} \left(\frac{t}{RC} \right)^3 + \dots \right) = \frac{V_{BB}}{R} e^{-\left(\frac{t}{RC} \right)}$$

$$u_0 = u(0) = \frac{V_{BB}}{R}$$

$$u_1 = u'(0) = -\frac{V_{BB}}{R^2 C}$$

$$u_2 = u''(0) = \frac{V_{BB}}{R^3 C^2}$$

$$u_3 = u'''(0) = -\frac{V_{BB}}{R^4 C^3}$$

.....

$$u(\lambda) = \sum_{n=0}^{\infty} \lambda^n u_n$$

$$u_n = \frac{1}{n!} \left[\frac{d^n u(\lambda)}{d\lambda^n} \right]_{\lambda=0}$$

The series solution obtained is Maclurain series around origin

Decomposing the series solution for the second order system:

$$u(t) = \frac{1}{m}t - \frac{k}{m^2} \frac{t^3}{3!} + \frac{k^2}{m^3} \frac{t^5}{5!} - \frac{k^3}{m^4} \frac{t^7}{7!} = \frac{1}{m} \left[t - \frac{k}{m} \frac{t^3}{3!} + \frac{k^2}{m^2} \frac{t^5}{5!} - \dots \right]$$

$$u_0 = u(0) = 0$$

$$u_1 = u'(0) = \frac{1}{m}$$

$$u_2 = u''(0) = 0$$

$$u_3 = u'''(0) = \frac{k}{m^2}$$

.....

$$u(\lambda) = \sum_{n=0}^{\infty} \lambda^n u_n$$

$$u_n = \frac{1}{n!} \left[\frac{du(\lambda)}{d\lambda^n} \right]_{\lambda=0}$$

The series solution obtained is Maclurain series around origin

Observations:

The series solution obtained as modal reactions individually, gets summed up at the origin to give total solution. The total series solution when decomposed can be treated as Maclurain's series around origin. The (constant) coefficients of the Maclurain's series, then jump out of the 'well' at the origin and then individually to give individual modal reactions as a power-law $u_n x^n$; these coefficients are the strength of curvature of the total solution at the origin that is $u^{(n)}(0)$. The total solution is then $u(x) = \sum_{n=0}^N u_n x^n$

The N could have finite or infinite terms. Thus the series solution in general may be a truncated series or even infinite series. This truncation could be after one term, or N finite terms, depending on the strength of curvature at the origin. For example a solution $u(t) = u_0 t$ is having one term, and no other term.

The individual modes $u_n x^n$ are in general are polynomial (in our this example is monomial though). Well if in the system of differential equation some terms of function of $u(x)$ exists as $N(u) = N(u(x))$, where $u(x) = \sum_{n=0}^{\infty} u_n x^n$ then $N(u)$ too can be decomposed as Maclurain's series $N(u) = \sum_{n=0}^{\infty} x^n A_n$ with polynomials A 's as $A_n = \frac{1}{n!} \left[\frac{d^n}{dx^n} N \left(\sum_{k=0}^{\infty} x^k u_k \right) \right]_{x=0}$

Mathematical Principle of Decomposition (Adomian's Polynomial & ADM)

G. Adomian (1989)

The physical description and then obtaining decomposed solution matches well with the ADM. From the previous example we generalize the system of General Differential Equations and give action-reaction laws to it so that one can obtain the solution by decomposition into infinite (or finite) modes. Let there be general differential equation system as:

$$D_x^m u(x) + a_1 D_x^{m-1} u(x) + a_2 D_x^{m-2} u(x) + \dots + a_m u(x) + b_k [u(x)]^k + b_{k-1} [u(x)]^{k-1} + \dots b_0 u(x) = G(x)$$

We can write this as:

$$Lu(x) = G(x) - R(u) - N(u)$$

$G(x)$ is sum of all external stimulus source/sink.

$L(u) = d^m u(x) / dx^m = D_x^m u(x)$ represents a linear operator representing the highest orders of change in the process parameter, which is easily invertible. This order of change could be one two, or any positive integer or even fractional (say half, one fourth, one and three quarter).

$R(u) = a_1 D_x^{m-1} + a_2 D_x^{m-2} + \dots + a_{m-1} D_x^1$ is the remainder differential operator of order $< m$

$$N(u) = a_m u(x) + b_k [u(x)]^k + b_{k-1} [u(x)]^{k-1} + \dots b_0 u(x)$$

contains nonlinear (as well be the linear) terms.

ADM:

$$Lu(x) = G(x) - R(u) - N(u)$$

$$u = \Phi + L^{-1}G - L^{-1}[R(u)] - L^{-1}[N(u)]$$

Φ is of the solution of homogeneous equation $Lu = 0$ so that $L\Phi = 0$

For a damped oscillator as follows:

$$m \frac{d^2 x}{dt^2} + c \frac{dx}{dt} + kx = f(t) \quad \text{Then } L = D_t^2, R = D_t^1, N(x) = x \cdot$$

$$x(t) = \Phi + \frac{1}{m} L^{-1} f - \frac{c}{m} L^{-1} R - \frac{k}{m} L^{-1} N$$

$$\Phi = u(0) + t \dot{u}(0)$$

$$L^{-1} f(t) \equiv D_t^{-2} f(t) = \int_0^t \int_0^t f(t) dt dt$$

For decomposition of the $N(u)$ part, define a “grouping” parameter close to one as λ

Then function is
$$u(\lambda) = \sum_{n=0}^{\infty} \lambda^n u_n = u_0 + \lambda u_1 + \lambda^2 u_2 + \dots$$

ADM: $u(\lambda) = \sum_{n=0}^{\infty} \lambda^n u_n = u_0 + \lambda u_1 + \lambda^2 u_2 + \dots$

This is Maclurain series with respect to λ with u_n 's as coefficients of the Maclurain series around $\lambda = 0$

that is $u_n = \frac{u^{(n)}(0)}{n!}$ Then $N(u)$ in Maclurain, series with respect to λ we obtain

$$N(u) = \sum_{n=0}^{\infty} \lambda^n A_n \quad A_n = \frac{1}{n!} \left[\frac{d^n}{d\lambda^n} N \left(\sum_{k=0}^{\infty} \lambda^k u_k \right) \right]_{\lambda=0}$$

$$\begin{aligned} u_0 &= \Phi + L^{-1}G \\ u_1 &= -L^{-1} [R(u_0)] - L^{-1}(A_0) \\ u_2 &= -L^{-1} [R(u_1)] - L^{-1}(A_1) \\ &\dots \dots \\ u_n &= -L^{-1} [R(u_{n-1})] - L^{-1}(A_{n-1}), \quad n \geq 1 \end{aligned}$$

$$\phi_N(t) = \sum_{n=0}^N u_n(t)$$

For obtaining Adomian's Polynomials

$$N(u) = \sum_{n=0}^{\infty} \lambda^n A_n \qquad u(\lambda) = \sum_{n=0}^{\infty} \lambda^n u_n = u_0 + \lambda u_1 + \lambda^2 u_2 + \dots$$

$$N(u_0 + \lambda u_1 + \lambda^2 u_2 + \dots) = A_0 + \lambda A_1 + \lambda^2 A_2 + \lambda^3 A_3 + \dots$$

Put $\lambda = 0$, to get $N(u_0) = A_0$

Differentiate once, with respect to λ we get: $\frac{d}{d\lambda}[N(u_0 + \lambda u_1 + \lambda^2 u_2 + \dots)] = \frac{d}{d\lambda}(A_0 + \lambda A_1 + \lambda^2 A_2 + \dots)$

$$\frac{\partial N(u_0 + \lambda u_1 + \lambda^2 u_2 + \dots)}{\partial(u_0 + \lambda u_1 + \lambda^2 u_2 + \dots)} \frac{\partial}{\partial \lambda}(u_0 + \lambda u_1 + \lambda^2 u_2 + \dots) = A_1 + 2\lambda A_2 + 3\lambda^2 A_3 + \dots$$

Differentiating once, more with respect to λ Put $\lambda = 0$ in above to get: $A_1 = u_1 \frac{dN(u_0)}{du_0} = u_1 N'(u_0)$

$$\frac{d}{d\lambda} \left[\frac{\partial N(u_0 + \lambda u_1 + \dots)}{\partial(u_0 + \lambda u_1 + \dots)} \frac{\partial}{\partial \lambda}(u_0 + \lambda u_1 + \dots) \right] = \frac{d}{d\lambda}(A_1 + 2\lambda A_2 + 3\lambda^2 A_3 + \dots)$$

$$\frac{\partial}{\partial \lambda}(u_0 + \lambda u_1 + \dots) \frac{d}{d\lambda} \left[\frac{\partial N(u_0 + \lambda u_1 + \dots)}{\partial(u_0 + \lambda u_1 + \dots)} \right] + \frac{\partial N(u_0 + \lambda u_1 + \dots)}{\partial(u_0 + \lambda u_1 + \dots)} \frac{d}{d\lambda} \frac{\partial}{\partial \lambda}(u_0 + \lambda u_1 + \dots) = 2A_2 + 3! \lambda A_3 + \dots$$

$$(u_1 + 2\lambda u_2 + \dots) \frac{\partial^2 N(u_0 + \lambda u_1 + \dots)}{\partial(u_0 + \lambda u_1 + \dots)^2} \frac{\partial}{\partial \lambda}(u_0 + \lambda u_1 + \dots) + \frac{\partial N(u_0 + \lambda u_1 + \dots)}{\partial(u_0 + \lambda u_1 + \dots)} (2u_2 + 3\lambda u_3 + \dots) = 2A_2 + \dots$$

Putting $\lambda=0$ in above expression, we obtain:

$$u_1^2 \frac{\partial^2 N(u_0)}{\partial u_0^2} + 2u_2 \frac{\partial N(u_0)}{\partial u_0} = 2A_2, \text{ implying} \qquad A_2 = u_2 \frac{dN(u_0)}{du_0} + \frac{u_1^2}{2} \frac{d^2 N(u_0)}{du_0^2} = u_2 N'(u_0) + \frac{1}{2} u_1^2 N''(u_0)$$

The Adomian's Polynomials

$$A_0 = A_0(u_0) = N(u(\lambda))_{\lambda=0} = N(u_0 + \lambda u_1 + \lambda^2 u_2 + \dots)_{\lambda=0} = N(u_0)$$

$$A_1 = A_1(u_0, u_1) = \left(\frac{\partial N}{\partial u} \right) \left(\frac{\partial u}{\partial \lambda} \right)_{\lambda=0}$$

$$A_2 = A_2(u_0, u_1, u_2) = \frac{1}{2} \left[\left(\frac{\partial^2 N}{\partial u^2} \right) \left(\frac{\partial u}{\partial \lambda} \right)^2 + \left(\frac{\partial N}{\partial u} \right) \left(\frac{\partial^2 u}{\partial \lambda^2} \right) \right]_{\lambda=0}$$

$$A_3 = A_3(u_0, u_1, u_2, u_3) = \frac{1}{6} \left[\left(\frac{\partial^3 N}{\partial u^3} \right) \left(\frac{\partial u}{\partial \lambda} \right)^3 + 3 \left(\frac{\partial^2 N}{\partial u^2} \right) \left(\frac{\partial u}{\partial \lambda} \right) \left(\frac{\partial^2 u}{\partial \lambda^2} \right) + \left(\frac{\partial N}{\partial u} \right) \left(\frac{\partial^3 u}{\partial \lambda^3} \right) \right]_{\lambda=0}$$

$$A_0 = N(u_0)$$

$$A_1 = u_1 \left(\frac{d}{du_0} \right) N(u_0) = u_1 N'(u_0)$$

$$A_2 = u_2 \left(\frac{d}{du_0} \right) N(u_0) + \frac{u_1^2}{2!} \left(\frac{d^2}{du_0^2} \right) N(u_0) = u_2 N'(u_0) + \frac{1}{2!} u_1^2 N''(u_0)$$

$$A_3 = u_3 \left(\frac{d}{du_0} \right) N(u_0) + u_1 u_2 \left(\frac{d^2}{du_0^2} \right) N(u_0) + \frac{u_1^3}{3!} \left(\frac{d^3}{du_0^3} \right) N(u_0) = u_3 N'(u_0) + u_1 u_2 N''(u_0) + \frac{u_1^3}{3!} N'''(u_0)$$

Adomian's Polynomials for Linear or Non-linear parts of System

$$N_1(x) = x^2 = \sum_{n=0}^{\infty} \lambda^n A_n \quad \text{Square non-linearity}$$

$$A_0 = x_0^2$$

$$A_1 = 2 x_0 x_1$$

$$A_2 = x_1^2 + 2 x_0 x_2$$

$$A_3 = 2 x_0 x_3 + 2 x_0 x_2 \dots\dots$$

$$N_2(x) = x^3 = \sum_{n=0}^{\infty} \lambda^n A_n \quad \text{Cubic non-linearity}$$

$$A_0 = x_0^3$$

$$A_1 = 3 x_0^2 x_1$$

$$A_2 = 3 x_0^2 x_2 + 3 x_1^2 x_0$$

$$A_3 = 3 x_0^2 x_3 + 6 x_0 x_1 x_2 + x_1^3 \dots\dots\dots$$

$$N_0(x) = x = \sum_{n=0}^{\infty} \lambda^n A_n \quad \text{Linear function} \quad A_0 = x_0 \quad \text{and} \quad A_n = x_n$$

$$N(x) = K \quad \text{Constant function} \quad A_0 = N_0(x_0) = K$$

$$A_1 = A_2 = \dots\dots\dots = A_{\infty} = 0$$

ADM and internal modal reactions (comparison)

$$Lu(x) = G(x) - R(u) - N(u)$$

$$u(\lambda) = u_0 + \lambda u_1 + \lambda^2 u_2 + \lambda^3 u_3 + \dots$$

$$u_0 = \Phi + L^{-1}G$$

$$N[u(\lambda)] = N(u_0 + \lambda u_1 + \lambda^2 u_2 + \dots)$$

$$= A_0 + \lambda A_1 + \lambda^2 A_2 + \lambda^3 A_3 + \dots$$

$$A_0 = N(u_0)$$

$$u_1 = -L^{-1}R(u_0) - L^{-1}(A_1)$$

$$A_1 = u_1 N'(u_0)$$

$$u_2 = -L^{-1}R(u_1) - L^{-1}(A_2)$$

$$A_2 = u_2 N'(u_0) + \frac{1}{2} u_1^2 N''(u_0)$$

$$u_3 = -L^{-1}R(u_2) - L^{-1}(A_3)$$

$$A_{n-1} = \frac{1}{(n-1)!} \left[\frac{d^{n-1} N \left(\sum_{k=0}^{\infty} \lambda^k u_k \right)}{d \lambda^{n-1}} \right]_{\lambda=0}$$

$$u_n = -L^{-1}R(u_{n-1}) - L^{-1}(A_n)$$

$$u(x) = \sum_{n=0}^{\infty} u_n$$

$$m D_t^2 x(t) + k x(t) = f(t)$$

$$L^{-1} = D_t^{-2} \quad G = \frac{1}{m} f(t) = \frac{1}{m} \delta(t) \quad R(x) = 0 \quad N(x) = \frac{k}{m} x$$

$$\Phi = \mathbf{x}(0) + t \dot{\mathbf{x}}(0) = 0 \quad A_0 = \frac{k}{m} x_0 \quad A_n = \frac{k}{m} x_n$$

$$x_0 = \Phi + L^{-1}G = D_t^{-2} \frac{1}{m} \delta(t) = \frac{1}{m} t$$

$$A_0 = \frac{k}{m} x_0 = \frac{k}{m^2} t$$

$$x_1 = -L^{-1}R(x) - L^{-1}(A_0) = -D_t^{-2} \left[\frac{k}{m^2} \right] = -\frac{k}{m^2} \frac{t^3}{3!}$$

$$A_1 = \frac{k}{m} x_1 = -\frac{k^2}{m^3} \frac{t^3}{3!}$$

$$x_2 = -L^{-1}R(x) - L^{-1}(A_1) = -D_t^{-2} (-t^3 / 3!) = \frac{k^2}{m^3} \frac{t^5}{5!}$$

$$x(t) = x_0 + x_1 + x_2 + x_3 + \dots = \frac{1}{m} t - \frac{k}{m^2} \frac{t^3}{3!} + \frac{k^2}{m^3} \frac{t^5}{5!} - \frac{k^3}{m^4} \frac{t^7}{7!} + \dots + \dots$$

$$x(t) = \frac{1}{m} \left[t - \frac{k}{m} \frac{t^3}{3!} + \frac{k^2}{m^2} \frac{t^5}{5!} - \dots \right] = \frac{1}{\sqrt{km}} \sin \left(\sqrt{\frac{k}{m}} t \right)$$

The above is exactly what was described in previous discussion with physical principles of action reaction generating all internal modes.

General Collision & Cohesion dynamics a NL system:

Two bodies collide the position variable is indentation w.r.t. time and force is non-linear Hertz force

$$\frac{m_1 m_2}{2(m_1 + m_2)} \frac{d^2 x}{dt^2} + K(n+1)x^n = 0 \quad x(0) = 0 \quad D_t^1 [x(t)]_{t=0} = \dot{x}(0) = u$$

$$\frac{d^2 x}{dt^2} = -a x^{3/2} \quad n=3/2 \quad a = \frac{5(m_1 + m_2)K}{m_1 m_2}$$

$$G = 0 \quad R = 0 \quad L^{-1} = D_t^{-2} \quad N(x) = ax^{3/2}$$

$$\Phi = x(0) + t\dot{x}(0) = ut$$

$$x_0 = \Phi + L^{-1}G = ut$$

$$A_0 = N(x_0) = ax_0^{3/2} = au^{3/2}t^{3/2}$$

$$x_1 = -L^{-1}R(x_0) - L^{-1}(A_0) = -D_t^{-2} \left[au^{3/2}t^{3/2} \right] = -\frac{4}{35} au^{3/2}t^{7/2}$$

$$A_1 = x_1 N'(x_0) = \frac{3}{2} ax_0^{1/2} x_1 = -\frac{12}{70} a^2 u^2 t^4$$

$$x_2 = -L^{-1}R(x_1) - L^{-1}(A_1) = -D_t^{-2} \left[-\frac{12}{70} a^2 u^2 t^4 \right] = \frac{12}{210} a^2 u^2 t^6$$

$$x(t) = ut - \frac{4 au^{3/2}}{35} t^{7/2} + \frac{12 a^2 u^2}{210} t^6 + \dots$$

A special case from generalization:

Force is independent of indentation (constant):

$$\frac{m_1 m_2}{2(m_1 + m_2)} \frac{d^2 x}{dt^2} + K(n+1)x^n = 0$$

$$\frac{m_1 m_2}{2(m_1 + m_2)} \frac{d^2 x}{dt^2} + K = 0$$

$$n = 0 \quad \frac{d^2 x}{dt^2} = -a \quad a = \frac{2(m_1 + m_2)K}{m_1 m_2}$$

$$N(x_0) = a = A_0 \quad N'(x) = 0$$

$$A_1 = 0 = A_2 = \dots = A_\infty$$

$$x_0 = \Phi + L^{-1}G = ut$$

$$x_1 = -L^{-1}A_0 = -D_t^{-2}(a) = -\frac{1}{2}at^2$$

$$x_2 = x_3 = \dots = x_\infty = 0$$

$$x(t) = ut - \frac{1}{2}at^2 \quad \text{Simple equation of motion!}$$

Example oscillator with fractional loss (damping) component, with modal reactions

$$\ddot{x}(t) + D_t^{1/2} x(t) + x(t) = f(t)$$

$$x(t) = x(0) + t\dot{x}(0) + D_t^{-2} f(t) - D_t^{-2} x(t) - D_t^{-3/2} x(t)$$

$$x(0) = 0, \dot{x}(0) = 0, f(t) = \delta(t)$$

Euler's generalization

$$D^{-n} x^m = \frac{\Gamma(m+1) x^{m-n}}{\Gamma(m-n+1)}$$

$$x_0(t) = D_t^{-2} \delta(t) = t$$

$$x_1(t) = -(D_t^{-3/2} + D_t^{-2})(t) = -\left(\frac{t^{5/2}}{\Gamma(7/2)} + \frac{t^3}{\Gamma(4)}\right)$$

$$x_2(t) = (D_t^{-3/2} + D_t^{-2})\left(\frac{t^{5/2}}{\Gamma(7/2)} + \frac{t^3}{\Gamma(4)}\right) = \frac{t^4}{\Gamma(5)} + 2\frac{t^{9/2}}{\Gamma(11/2)} + \frac{t^5}{\Gamma(6)}$$

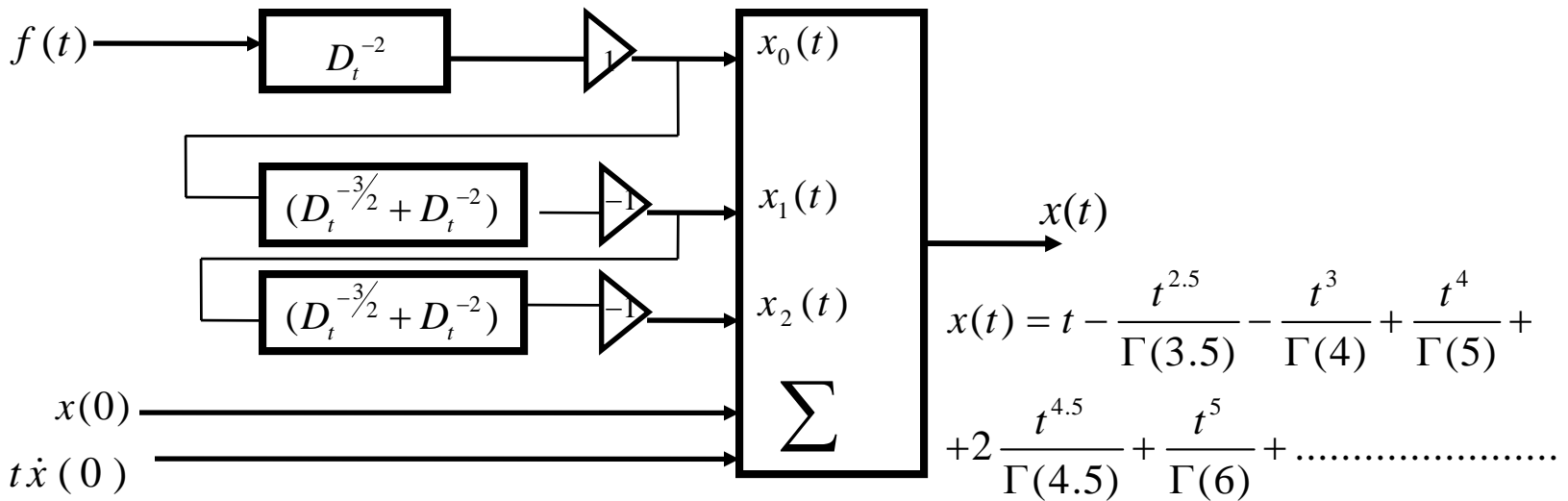

Solution is infinite series convergent with integer & fractional power terms

ADM and internal modal reactions (comparison)

Oscillator with fractional damping with Dirac's delta function as input forcing

$$\ddot{x}(t) + D_t^{1/2} x(t) + x(t) = f(t)$$

$$x(0) = 0, \dot{x}(0) = 0, f(t) = \delta(t)$$

$$L = D_t^2 \quad R = D_t^{1/2} \quad N(x) = x$$

$$G = \delta(t)$$

$$x_0 = \Phi + L^{-1}G = D_t^{-2} \delta(t) = t$$

$$A_0 = x_0 = t$$

$$x_1 = -L^{-1}R(x_0) - L^{-1}A_0 = -(D_t^{-3/2} + D_t^{-2})x_0 = -\left(\frac{t^{5/2}}{\Gamma(7/2)} + \frac{t^3}{\Gamma(4)}\right)$$

$$A_1 = x_1 = -\left(\frac{t^{5/2}}{\Gamma(7/2)} + \frac{t^3}{\Gamma(4)}\right)$$

$$x_2 = -L^{-1}R(x_1) - L^{-1}A_1 = -(D_t^{-3/2} + D_t^{-2})x_1 = \left(\frac{t^4}{\Gamma(5)} + 2\frac{t^{9/2}}{\Gamma(11/2)} + \frac{t^5}{\Gamma(6)}\right)$$

MODE	FORCE	DISPLACEMENT
0	$\delta(t)$	t
Higher Modes	Higher modal internal force	Higher modal internal displacement
1	$-t$	$-\frac{t^{5/2}}{\Gamma(3.5)} - \frac{t^3}{\Gamma(4)}$
2	$\frac{t^{5/2}}{\Gamma(3.5)} + \frac{t^3}{\Gamma(4)}$	$\frac{t^4}{\Gamma(5)} + 2\frac{t^{9/2}}{\Gamma(5.5)} + \frac{t^5}{\Gamma(6)}$
3	$-\frac{t^4}{\Gamma(5)} - 2\frac{t^{9/2}}{\Gamma(5.5)} - \frac{t^5}{\Gamma(6)}$	$-\frac{t^{11/2}}{\Gamma(6.5)} - \frac{t^6}{\Gamma(7)} - \frac{t^{13/2}}{\Gamma(7.5)} - \frac{t^7}{\Gamma(8)}$
.....

Table-2 Modal force and displacements for second order system with fractional order damping

Same reactions we obtained earlier by action reaction decomposition

Example oscillator with fractional loss (damping) component, Heaviside's step

function as input:

$$D_t^2 x(t) + \frac{c}{m} D_t^{1/2} x(t) + \frac{k}{m} x(t) = \frac{1}{m} f(t) \quad L[x(t)] = -\frac{c}{m} R[x(t)] + \frac{k}{m} N[x(t)] + \frac{1}{m} f(t)$$

$$x(0) = 0 \quad D_t^1 [x(t)]_{t=0} = \dot{x}(0) = 0 \quad f(t) = Fh(t) \quad L = D_t^2 \quad R = D_t^{1/2} \quad N(x) = x \quad G = \frac{Fh(t)}{m}$$

By application of ADM we obtain

Euler's relation

$$D_x^\alpha x^\beta = \frac{\Gamma(\beta + 1)}{\Gamma(\beta - \alpha + 1)} x^{\beta - \alpha}$$

$$x_0(t) = \frac{1}{m} D_t^{-2} f(t) = \frac{Ft^2}{2m}$$

$$x_1(t) = -\frac{c}{m} D_t^{-3/2} x_0(t) - \frac{k}{m} D_t^{-2} x_0(t) = -\frac{cF}{m^2} \frac{t^{7/2}}{\Gamma\left(\frac{9}{2}\right)} - \frac{kF}{m^2} \frac{t^4}{\Gamma(5)}$$

$$x_2(t) = -\frac{c}{m} D_t^{-3/2} x_1(t) - \frac{k}{m} D_t^{-2} x_1(t) = \frac{c^2 F}{m^3} \frac{t^5}{\Gamma(6)} + \frac{2kcF}{m^3} \frac{t^{11/2}}{\Gamma\left(\frac{13}{2}\right)} + \frac{k^2 F}{m^3} \frac{t^6}{\Gamma(7)}$$

$$x_3(t) = -\frac{c}{m} D_t^{-3/2} x_2(t) - \frac{k}{m} D_t^{-2} x_2(t)$$

$$x_3(t) = -\frac{c^3 F}{m^4} \frac{t^{13/2}}{\Gamma\left(\frac{15}{2}\right)} - \frac{3kc^2 F}{m^4} \frac{t^7}{\Gamma(8)} - \frac{3k^2 cF}{m^4} \frac{t^{15/2}}{\Gamma\left(\frac{17}{2}\right)} - \frac{k^3 F}{m^4} \frac{t^8}{\Gamma(9)}$$

$$x(t) = x_0(t) + x_1(t) + x_2(t) + x_3(t) + \dots + \dots$$

$$x(t) = \frac{F}{m} \sum_{r=0}^{\infty} \frac{(-1)^r}{r!} \left(\frac{k}{m}\right)^r t^{2(r+1)} \sum_{j=0}^{\infty} \left(\frac{-c}{m}\right)^j \frac{(j+r)! t^{3j/2}}{j! \Gamma\left(\frac{3j}{2} + 2r + 3\right)}$$

$$x(t) = \frac{F}{m} \sum_{r=0}^{\infty} \frac{(-1)^r}{r!} \left(\frac{k}{m}\right)^r t^{2(r+1)} E_{\frac{3}{2}, \frac{r}{2} + 3}^{(r)} \left(\frac{-c}{m} t^{3/2}\right)$$

Application of Decomposition Method in RL formulated Partial Fractional

Differential Equation

Linear Diffusion -Wave equation and solution to impulse forcing function:

$$\left[\frac{\partial^\alpha}{\partial t^\alpha} u(x, t) \right]_{RL} = \frac{\partial^2}{\partial x^2} u(x, t)$$

$$u(x, 0^+) = \delta(x) \quad u_t(x, 0^+) = 0 \quad G = 0$$

$$1 < \alpha < 2 \quad m = 2$$

This problem example elaborates that the time evolution of process parameter takes place without the forcing function present only the effect is due to initial value (in this case is Dirac's delta function as process parameter present at space-origin).

The fractional time rate of change of the process variable is related to spatial double derivative of the same as expressed . In the formulation of fractional derivative is of Riemann-Liouveli (RL) scheme. For RL scheme requirement is fractional initial states!!

Converting the above into Caputo derivative formulation, we obtain:

$${}^C \left[\frac{\partial^\alpha}{\partial t^\alpha} u(x, t) \right] + \frac{t^{-\alpha}}{\Gamma(1-\alpha)} u(x, 0) + \frac{t^{1-\alpha}}{\Gamma(2-\alpha)} \dot{u}(x, 0) = \frac{\partial^2}{\partial x^2} u(x, t)$$

Observation here states that the RL derivative of fractional order when changed to Caputo formulation gives rise to extra source/sink terms of the inverse power function of the independent variables in the constituent equation. In above after applying the definition of Caputo derivative in the fractional operator we get:

$$m = 2$$

$$D_t^{-(2-\alpha)} \left[\frac{\partial^2}{\partial x^2} u(x, t) \right] = \frac{\partial^2}{\partial x^2} u(x, t) - \frac{t^{-\alpha}}{\Gamma(1-\alpha)} u(x, 0) - \frac{t^{1-\alpha}}{\Gamma(2-\alpha)} \dot{u}(x, 0)$$

continue
$$D_t^{-(2-\alpha)} \left[\frac{\partial^2}{\partial t^2} u(x, t) \right] = \frac{\partial^2}{\partial x^2} u(x, t) - \frac{t^{-\alpha}}{\Gamma(1-\alpha)} u(x, 0) - \frac{t^{1-\alpha}}{\Gamma(2-\alpha)} \dot{u}(x, 0)$$

Inverting the above, we get:

$$\left[\frac{\partial^2}{\partial t^2} u(x, t) \right] = D_t^{(2-\alpha)} \left[\frac{\partial^2}{\partial x^2} u(x, t) \right] - \frac{u(x, 0)}{\Gamma(1-\alpha)} D_t^{(2-\alpha)} [t^{-\alpha}] - \frac{\dot{u}(x, 0)}{\Gamma(2-\alpha)} D_t^{(2-\alpha)} [t^{1-\alpha}]$$

Applying fractional derivative of the power function by Euler's expression

$$\left[\frac{\partial^2}{\partial t^2} u(x, t) \right] = D_t^{(2-\alpha)} \left[\frac{\partial^2}{\partial x^2} u(x, t) \right] - \frac{u(x, 0)}{\Gamma(1-\alpha)} \left[\frac{\Gamma(-\alpha+1)t^{-\alpha-2+\alpha}}{\Gamma(-\alpha+1-2+\alpha)} \right] - \frac{\dot{u}(x, 0)}{\Gamma(2-\alpha)} \left[\frac{\Gamma(1-\alpha+1)t^{1-\alpha-2+\alpha}}{\Gamma(1-\alpha+1-2+\alpha)} \right]$$

Simplifying above we obtain:

$$\left[\frac{\partial^2}{\partial t^2} u(x, t) \right] = D_t^{(2-\alpha)} \left[\frac{\partial^2}{\partial x^2} u(x, t) \right] - u(x, 0) \left[\frac{t^{-2\alpha}}{\Gamma(-1)} \right] - \dot{u}(x, 0) \left[\frac{t^{-1}}{\Gamma(0)} \right]$$

The last two terms of above gives zero; since reciprocal Gamma function is

zero at values zero and negative integer points giving the modified diffusion equation as:

$$\left[\frac{\partial^2}{\partial t^2} u(x, t) \right] = D_t^{(2-\alpha)} \left[\frac{\partial^2}{\partial x^2} u(x, t) \right]$$

continue
$$\left[\frac{\partial^2}{\partial t^2} u(x, t) \right] = D_t^{(2-\alpha)} \left[\frac{\partial^2}{\partial x^2} u(x, t) \right]$$

Taking the (space) Fourier Transform of we get the following with transformed initial conditions as:

$$\frac{\partial^2}{\partial t^2} \bar{u}(k, t) = -k^2 D_t^{(2-\alpha)} \bar{u}(k, t) \quad \bar{u}(k, 0) = \frac{1}{\sqrt{2\pi}} \quad \bar{u}_t(k, 0) = 0 \quad k \in \mathfrak{R}$$

and write with ADM the solution as:

$$\bar{u}(k, t) = \frac{1}{\sqrt{2\pi}} \int_{-\infty}^{+\infty} e^{ikx} u(x, t) dx$$

$$\bar{u}(k, t) = \Phi + L^{-1}G - L^{-1}R(u) - L^{-1}N(u)$$

$$\bar{u}(k, t) = \Phi + L^{-1}[D_t^{2-\alpha} \bar{u}(k, t)]$$

$$\bar{u}(k, t) = \bar{u}(k, 0) + t\bar{u}_t(k, 0) - k^2 D_t^{-2} [D_t^{2-\alpha} \bar{u}(k, t)] = \bar{u}(k, 0) - k^2 D_t^{-2} [D_t^{2-\alpha} \bar{u}(k, t)]$$

Here the $L^{-1} = D_t^{-2}$ $G = R = 0$ $N(u) = \bar{u}(k, t)$ is linear

Therefore $\bar{u}_0 = \Phi = \bar{u}_0(k, 0)$

and for $n \geq 1$ $\bar{u}_n = -L^{-1} D_t^{2-\alpha} \bar{u}_{n-1}$

we get
$$\bar{u}(k, t) = \sum_{n=0}^{\infty} \bar{u}_n(k, t)$$

continue

$$\bar{u}_0 = \frac{1}{\sqrt{2\pi}}$$

$$A_0 = \bar{u}_0$$

$$\bar{u}_1 = -L^{-1} D_t^{2-\alpha} [A_0] - k^2 D_t^{-2} [D_t^{2-\alpha} \bar{u}_0] = -\frac{k^2}{\sqrt{2\pi}} \left(\frac{t^\alpha}{\Gamma(\alpha + 1)} \right)$$

$$A_1 = \bar{u}_1$$

$$\bar{u}_2 = -k^2 D_t^{-2} [D_t^{2-\alpha} \bar{u}_1] = \frac{k^4}{\sqrt{2\pi}} \left(\frac{t^{2\alpha}}{\Gamma(2\alpha + 1)} \right)$$

$$A_2 = \bar{u}_2$$

$$\bar{u}_3 = -k^2 D_t^{-2} [D_t^{2-\alpha} \bar{u}_2] = -\frac{k^6}{\sqrt{2\pi}} \left(\frac{t^{3\alpha}}{\Gamma(3\alpha + 1)} \right)$$

.....

$$\bar{u}(k, t) = \frac{1}{\sqrt{2\pi}} \left[1 - \frac{k^2 t^\alpha}{\Gamma(\alpha + 1)} + \frac{k^4 t^{2\alpha}}{\Gamma(2\alpha + 1)} - \frac{k^6 t^{3\alpha}}{\Gamma(3\alpha + 1)} + \dots \right]$$

$$\bar{u}(k, t) = \frac{1}{\sqrt{2\pi}} \sum_{n=0}^{\infty} \frac{(k^2)^n t^{n\alpha}}{\Gamma(n\alpha + 1)} = \frac{1}{\sqrt{2\pi}} E_\alpha(-k^2 t^\alpha)$$

Taking the Inverse Fourier Transform of , we get solution to with impulse excitation as:

$$u(x, t) = \frac{1}{2} t^{-\alpha/2} M_{\alpha/2}(|x|/t^{\alpha/2})$$

$M_{\alpha/2}$ special case of Wright function

Fractional Nonlinear Differential equation

$$\frac{d^\alpha y}{dt^\alpha} = (1-y)^4 \quad 0 < \alpha < 1 \quad y(0^+) = 0 \quad L^{-1} = D_t^{-1} \quad \Phi = C = 0 \quad N(y) = (1-y)^4 = \sum_{n=0}^{\infty} \lambda^n A_n$$

$$y(t) = \sum_{n=0}^{\infty} y_n = \Phi + L^{-1} D_t^{1-\alpha} \sum_{n=0}^{\infty} A_n = D_t^{-1} \left[D^{1-\alpha} \sum_{k=0}^{\infty} A_n \right]$$

$$y_0 = 0 \quad A_0 = (1-y_0)^4 = 1$$

$$y_1(t) = D_t^{-1} D_t^{1-\alpha} [A_0] = D_t^{-1} D_t^{1-\alpha} (1) = \frac{t^\alpha}{\Gamma(\alpha + 1)}$$

$$A_1 = y_1 N'(y_0)$$

$$N'(y_0) = \frac{d}{dy_0} (1-y_0)^4 = -4(1-y_0)^3 = -4$$

$$A_1 = y_1(-4) = -\frac{4t^\alpha}{\Gamma(\alpha + 1)}$$

$$y_2(t) = D_t^{-1} D_t^{1-\alpha} [A_1] = D_t^{-1} D_t^{1-\alpha} \left[\frac{-4t^\alpha}{\Gamma(\alpha + 1)} \right] = \frac{-4t^{2\alpha}}{\Gamma(2\alpha + 1)}$$

$$A_2 = y_2 N'(y_0) + \frac{y_1}{2!} N''(y_0)$$

$$N''(y_0) = \frac{d^2}{dy_0^2} (1-y_0)^4 = 12(1-y_0)^2 = 12$$

$$N'(y_0) = -4$$

$$A_2 = \left(\frac{-4t^{2\alpha}}{\Gamma(2\alpha + 1)} \right) (-4) + \frac{12}{2} \left(\frac{t^\alpha}{\Gamma(\alpha + 1)} \right)^2 = \frac{6\Gamma(2\alpha + 1) - 16[\Gamma(\alpha + 1)]^2}{\Gamma(2\alpha + 1)[\Gamma(\alpha + 1)]^2} t^{2\alpha}$$

$$y_3(t) = D_t^{-1} D_t^{1-\alpha} [A_2] = \frac{6\Gamma(2\alpha + 1) - 16[\Gamma(\alpha + 1)]^2}{\Gamma(3\alpha + 1)[\Gamma(\alpha + 1)]^2} t^{3\alpha}$$

$$y(t) = \frac{1}{\Gamma(\alpha + 1)} t^\alpha - \frac{4}{\Gamma(2\alpha + 1)} t^{2\alpha} + \frac{6\Gamma(2\alpha + 1) - 16[\Gamma(\alpha + 1)]^2}{\Gamma(3\alpha + 1)[\Gamma(\alpha + 1)]^2} t^{3\alpha} + \dots \dots \dots$$

Fractional Diffusion-Wave Equation solution by

Decomposition

$$\frac{\partial^\alpha}{\partial t^\alpha} u(x, t) = \frac{\partial^2}{\partial x^2} u(x, t) \quad u(x, 0^+) = \sin x \quad \frac{\partial u(x, 0^+)}{\partial t} = u_t(x, 0^+) = 0$$

$$1 < \alpha \leq 2 \quad m=2$$

$$u(x, t) = \Phi + L_t^{-1} \left(D_t^{m-\alpha} \left[\frac{\partial^2}{\partial x^2} u(x, t) \right] \right) \quad m = 2 \quad L^1 = D_t^{-2} \quad \Phi = u(x, 0) + t \frac{\partial}{\partial t} u(x, 0) = \sin x$$

$$u_0 = \Phi = \sin x$$

$$u_1 = L^{-1} \left(D_t^{2-\alpha} \left[\frac{\partial^2}{\partial x^2} u_0 \right] \right) = D_t^{-2} \left(D_t^{2-\alpha} \left[\frac{\partial^2}{\partial x^2} \sin x \right] \right) = - \frac{t^\alpha}{\Gamma(\alpha + 1)} \sin x$$

$$u_2 = L^{-1} \left(D_t^{2-\alpha} \left[\frac{\partial^2}{\partial x^2} u_1 \right] \right) = D_t^{-2} \left(D_t^{2-\alpha} \left[\frac{\partial^2}{\partial x^2} \left\{ - \frac{t^\alpha}{\Gamma(\alpha + 1)} \right\} \sin x \right] \right) = \frac{t^{2\alpha}}{\Gamma(2\alpha + 1)} \sin x$$

$$u_3 = L^{-1} \left(D_t^{2-\alpha} \left[\frac{\partial^2}{\partial x^2} u_2 \right] \right) = D_t^{-2} \left(D_t^{2-\alpha} \left[\frac{\partial^2}{\partial x^2} \left\{ \frac{t^{2\alpha}}{\Gamma(2\alpha + 1)} \right\} \sin x \right] \right) = - \frac{t^{3\alpha}}{\Gamma(3\alpha + 1)} \sin x$$

.....

$$u(x, t) = u_0 + u_1 + u_2 + \dots = \left(\sum_{n=0}^{\infty} \frac{(-t^\alpha)^n}{\Gamma(n\alpha + 1)} \right) \sin x$$

Thoughts & Observation

A general law of nature (balance equation) $Lu(x) = G(x) - R(u) - N(u)$

First reacts to external force giving the zeroth mode of reaction: $u_0 = \Phi + L^{-1}G$

Then it manifests as “internal” excitation to which higher modes keeps on generating giving modal reactions as series by the “same physical law”

$$u_n = -L^{-1} [R(u_{n-1})] - L^{-1}(A_{n-1}), n \geq 1$$

Well then if a physical system may thwart the external stimulus, then internal modes gets generated and the summation of all these internal modes we observe as total reaction.

All the higher modes are self similar and fractal type- what is the scale? Seems to act together at the “origin”.

Can we isolate one single mode?

Is it the way all action-reaction processes work?

Well is this an universal fact of natural reaction?

Comment-Physical Law & EODE!

The Decomposition Method of Mathematics of Linear and Functional Analysis, as demonstrated is generalization of the physical law of nature, that is the process reacts in opposite way to thwart any changes in the process variable. The Decomposition Method as explained for physical systems gives insight into micro-scale reactions, to the external or internal stimulus-as to oppose the changes; thereby generating infinite (or finite) modes of reactions, the sum of which gives the total system behavior. Fractional Differential Equation (FDE) by RL method it is found that there is no need to worry about the fractional initial states; instead one can use integer order initial states (the conventional ones) to arrive at solution of FDE. This way one gets insight to Physics of General Differential Equation Systems-and its solution-by Physical Principle and equivalent mathematical decomposition method. This facilitates ease in modeling to get approximate analytic behavior of General Dynamic System-involving Extra Ordinary Differential Equations.

Continuous Order Differential Equation

A lumped system, spring dash pot, or RL circuit is ODE, system without memory!

$$K_1 \frac{d}{dt} f(t) + K_0 f(t) = g(t)$$

A fractional generalization gives a system with memory

$$K_1 \frac{d^q}{dt^q} f(t) + K_0 f(t) = g(t)$$

A fractional order system with several fractionally damped element

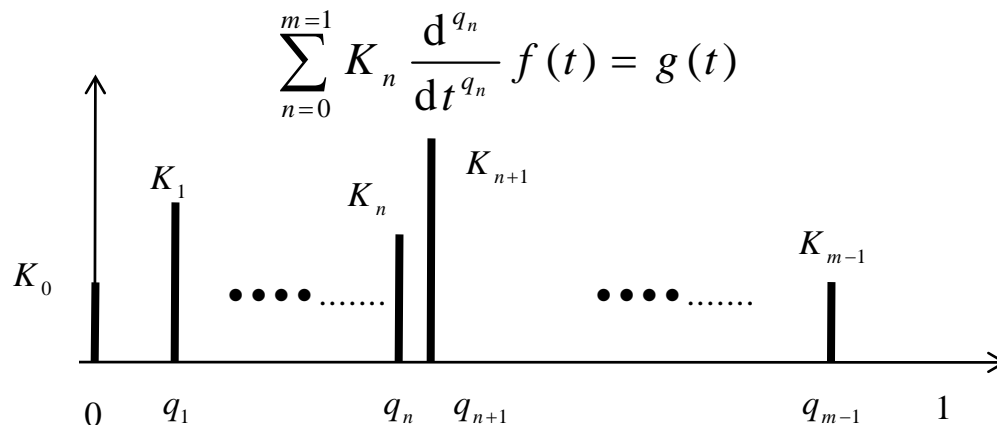

Order is distributed continuously as linear function

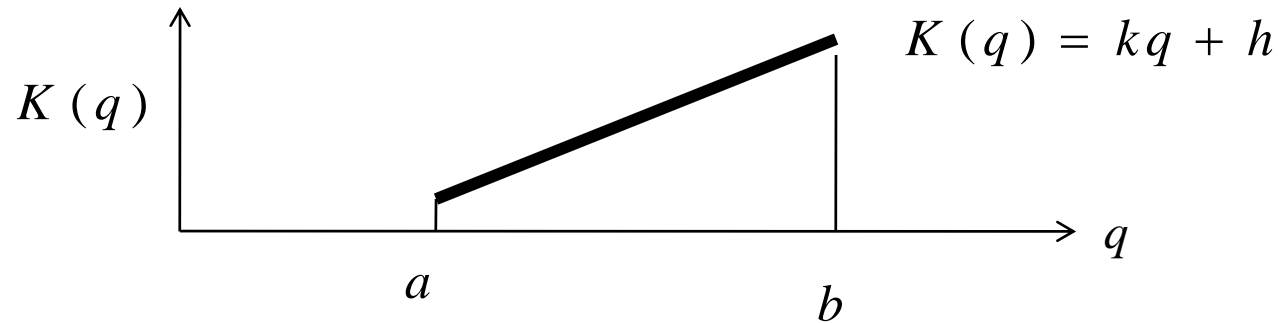

$$\sum_{n=0}^{m=1} K_n \frac{d^{q_n}}{dt^{q_n}} f(t) = g(t) \quad \text{The summation } \Sigma \text{ is changed to } \int$$

**We get Continuous Order Differential Equation
(infinite memory !!)**

$$\int_a^b \left(K(q) \frac{d^q}{dt^q} f(t) \right) dq = g(t)$$

Laplace Transforming the Continuous Order Differential equation

$$\int_a^b \left[K(q) \frac{d^{m+q}}{dt^{m+q}} f(t) \right] dq = \int_a^b \left[\frac{K(q)}{\Gamma(1-q)} dq \right] \left[\int_0^t \frac{f^{(m+1)}(u)}{(t-u)^q} du \right] = g(t)$$

Used definition of FD $\frac{d^{m+q}}{dt^{m+q}} f(t) = \frac{1}{\Gamma(1-q)} \int_0^t \frac{f^{(m+1)}(u)}{(t-u)^q} du$ $m < (m+q) < (m+1)$
 $m \in \mathbb{Z}$ $q \in \mathbb{R}$

Taking Laplace Transform

$$\int_a^b K(q) dq \left[s^{m+q} F(s) - s^q \sum_{n=0}^m s^{n-1} f^{(m-n)}(0) \right] = G(s)$$

For initial states zero the solution in Laplace domain is

$$F(s) = \frac{G(s)}{s^m \int_a^b K(q) s^q dq} = \frac{G(s)}{\Phi(s)}$$

$$\Phi(s) = s^m \int_a^b s^q K(q) dq$$

Frequency Response of Continuous order system

For a order distribution $K(q) = kq + h$ in the interval $[a, b]$ the transfer function looks like:

$$\begin{aligned}\Phi(s) &= s^m \int_a^b s^q K(q) dq \\ &= s^m \int_a^b s^q (kq + h) dq \\ &= s^m \frac{[(kb + h)s^b - (ka + h)s^a] - \frac{k(s^b - s^a)}{\ln s}}{\ln s}\end{aligned}$$

For a uniform order distribution case $k=0$; $h=1$ the transfer function is

$$\Phi(s) = \frac{(s^b - s^a) s^m}{\ln s}$$

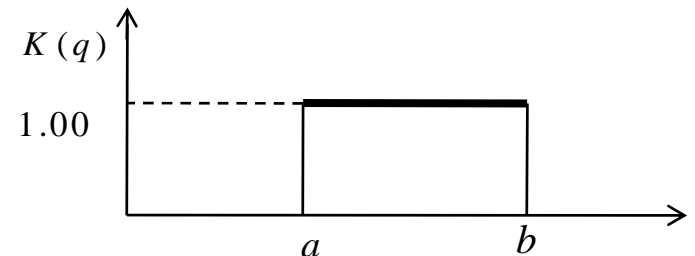

The frequency response plot of continuous order transfer function

$$\Phi(s) = \frac{s^m (s^b - s^a)}{\ln s}$$

Putting $s = i\omega$ we will get Bode plot

$$\ln(i\omega) = \ln\left[|\omega| e^{i(\pi/2)}\right] = \ln|\omega| + i\left(\frac{\pi}{2}\right) \quad \text{giving} \quad |\ln s| = \sqrt{(\ln \omega)^2 + (\pi/2)^2}$$

$$s^b = (i\omega)^b = |\omega|^b \angle(b\pi/2) \quad s^a = (i\omega)^a = |\omega|^a \angle(a\pi/2)$$

$$|A - B| = \sqrt{|A|^2 + |B|^2 - 2|A||B|\cos(\angle A - \angle B)}$$

$$|\Phi(i\omega)| = \frac{\sqrt{\omega^{2b} + \omega^{2a} - 2\omega^{a+b} \cos\left(\frac{\pi}{2}(b-a)\right)}}{\sqrt{(\ln \omega)^2 + (\pi/2)^2}} (\omega)^m$$

Solution of continuous order differential equation in frequency domain is thus

$$|F(i\omega)| = \frac{|G(i\omega)|}{|\Phi(i\omega)|} = \frac{\sqrt{(\ln \omega)^2 + (\pi/2)^2}}{\omega^m \sqrt{\omega^{2b} + \omega^{2a} - 2\omega^{a+b} \cos\left(\frac{\pi}{2}(b-a)\right)}}$$

The time domain solution of continuous order differential equation

$$\begin{aligned}
 f(t) &= \mathcal{L}^{-1}\{F(s)\} = \mathcal{L}^{-1} \frac{G(s)}{\Phi(s)} \\
 &= \mathcal{L}^{-1} \left\{ G(s) \frac{\ln s}{s^a (s^{b-a} - 1) s^m} \right\} \\
 &= g(t) \otimes \mathcal{L}^{-1} \left\{ \frac{\ln s}{s^a} \right\} \otimes \mathcal{L}^{-1} \left\{ \frac{1}{s^{b-a} - 1} \right\} \otimes \mathcal{L}^{-1} \left\{ \frac{1}{s^m} \right\} \\
 &= g(t) \otimes \mathcal{L}^{-1} \left\{ \frac{\ln s}{s^a} \right\} \otimes F_{(b-a)}(1, t) \otimes \frac{t^{m-1}}{\Gamma(m)}
 \end{aligned}$$

Robotnov Hartley function $F_q(a, t) = t^{(q-1)} \sum_{n=0}^{\infty} \frac{a^n t^{nq}}{\Gamma(nq + q)}$

Laplace inverse of function with out poles in left half plane!!

Inverse Laplace of function with no roots in Left Half Plane

$$\bar{\Phi}(s) = \frac{s^b - s^a}{s \ln s} \quad 0 < a < b < 1$$

$$G(s) = [\Phi(s) / s][sF(s)] = \bar{\Phi}(s)F'(s)$$

Why ? So as to make $\bar{\Phi}(s) \rightarrow 0$ at $s = \infty$. The inspection says that due to $\ln(s)$ there is no possibility of roots in negative plane! The logarithm is also multi-valued function, so as the power functions of non-integer orders; they have standard branch cut in complex plane that is $(-\infty, 0]$

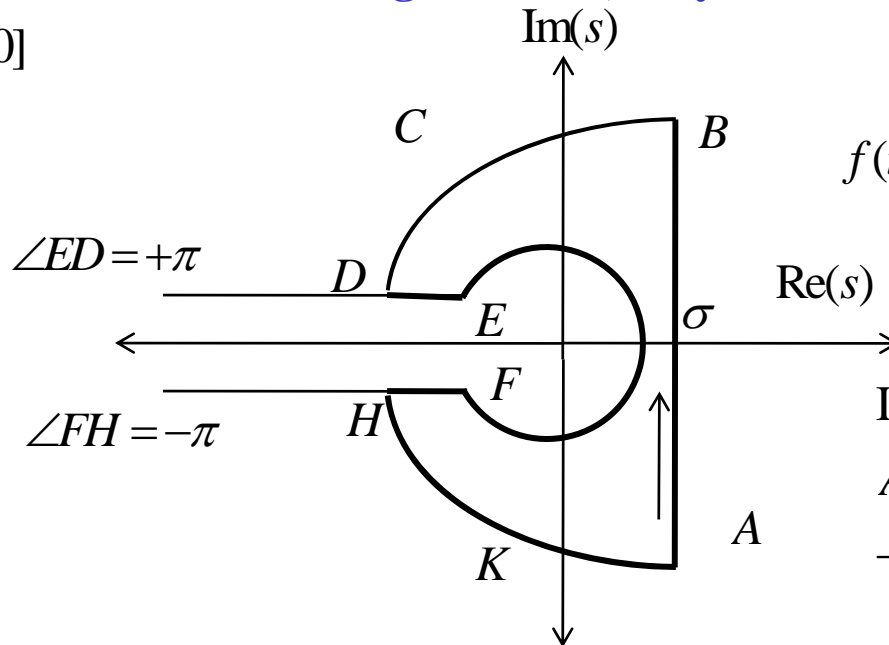

$$f(t) = \mathcal{L}^{-1}\{F(s)\} = \frac{1}{2\pi i} \lim_{T \rightarrow \infty} \int_{\sigma - iT}^{\sigma + iT} e^{st} F(s) ds$$

Integration - contour

$A \rightarrow B \rightarrow C \rightarrow D \rightarrow E$

$\rightarrow F \rightarrow H \rightarrow K \rightarrow A$

Apply residue theorem

Since the integration on large arc BCD and HKA is zero at large radius, and as the radius goes to zero the integration on the small arc EF is zero, we are left with:

$$\oint_{A,B,C,\dots,K,A} e^{st} \bar{\Phi}(s) ds = \int_A^B e^{st} \bar{\Phi}(s) ds + \int_D^E e^{st} \bar{\Phi}(s) ds + \int_F^H e^{st} \bar{\Phi}(s) ds = 2\pi i \sum \text{residue of poles}$$

Rearranging above and recognizing that contour does not enclose any poles we get

$$\frac{1}{2\pi i} \int_{\sigma-i\infty}^{\sigma+i\infty} e^{st} \bar{\Phi}(s) ds + \frac{1}{2\pi i} \int_D^E e^{st} \bar{\Phi}(s) ds + \frac{1}{2\pi i} \int_F^H e^{st} \bar{\Phi}(s) ds = \frac{1}{2\pi i} \oint e^{st} \bar{\Phi}(s) ds = \sum \text{residues of poles} = 0$$

From above we have Laplace inverse as

$$\mathcal{L}^{-1} \{ \bar{\Phi}(s) \} = \frac{1}{2\pi i} \int_{\sigma-i\infty}^{\sigma+i\infty} e^{st} \bar{\Phi}(s) ds = -\frac{1}{2\pi i} \left[\int_D^E e^{st} \bar{\Phi}(s) ds + \int_F^H e^{st} \bar{\Phi}(s) ds \right]$$

The result in form of Bestimmte Integral

Use $s = re^{i\theta}$ on $\theta = \pm\pi$ we have $s = -r$ and $ds = -dr$

$$\begin{aligned}\mathcal{L}^{-1}\{\bar{\Phi}(s)\} &= -\frac{1}{2\pi i} \left[\int_D^E e^{st} \bar{\Phi}(s) ds + \int_F^H e^{st} \bar{\Phi}(s) ds \right] \\ &= -\frac{1}{2\pi i} \left[-\int_{\infty}^0 e^{-rt} \bar{\Phi}(r, \theta = \pi) dr - \int_0^{\infty} e^{-rt} \bar{\Phi}(r, \theta = -\pi) dr \right] \\ &= \frac{1}{2\pi i} \left[\int_0^{\infty} e^{-rt} (\bar{\Phi}(r, \theta = \pi) - \bar{\Phi}(r, \theta = -\pi)) dr \right]\end{aligned}$$

Doing lot of algebra we obtain Laplace inverse of continuous order transfer function
In form of Bestimmte integral; the Green's function is thus obtained for getting the
time domain solution

$$\mathcal{L}^{-1}\{\bar{\Phi}(s)\} = \frac{1}{\pi} \int_0^{\infty} e^{-rt} \frac{\left[r^{b-1} \{-\ln r \sin(b\pi) + \pi \cos(b\pi)\} + r^{a-1} \{\ln r \sin(a\pi) - \pi \cos(a\pi)\} \right]}{[(\ln r)^2 + \pi^2]} dr$$

I am again at the very beginning

**will try again to ‘fractionally’ learn
the beautiful subject**

the Fractional Calculus

what nature understands the best

Thanking you all